



C - PS



C - GGC



C - FSV



C - TMBV

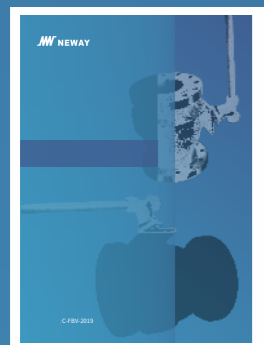

C - FBV



C - CBV



C - MMBV



C - FWBV



C - BFV



C - DOV

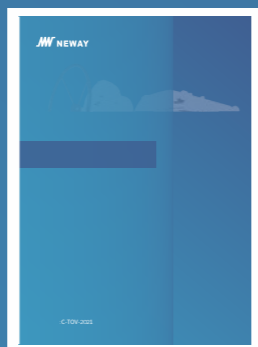

C - TOV



C - CPS

JW NEWAY

JW NEWAY

666

0512-666-21954

Domestic.sales@neway.com.cn

<https://www.neway.com.cn/>

:C-PGV-2025

:C-PGV-2025





603699)



NORSOK



ISO9001



CE/PED

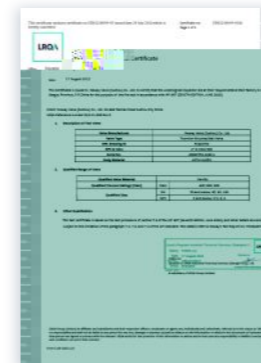

TA Luft



ABS



AD2000

1 1 3 1 1 230,000

Ansys Fe-safe CF-design SiemensPLM NX

SAP

80

ISO API

ISO 9001 , API 6A, API 6D, API 600

CE-PED AD2000 TA-Luft,

API 624, ISO 15848

API 607, API 6FA

1
2-9
10-17
18
19
20



60%。

/ /

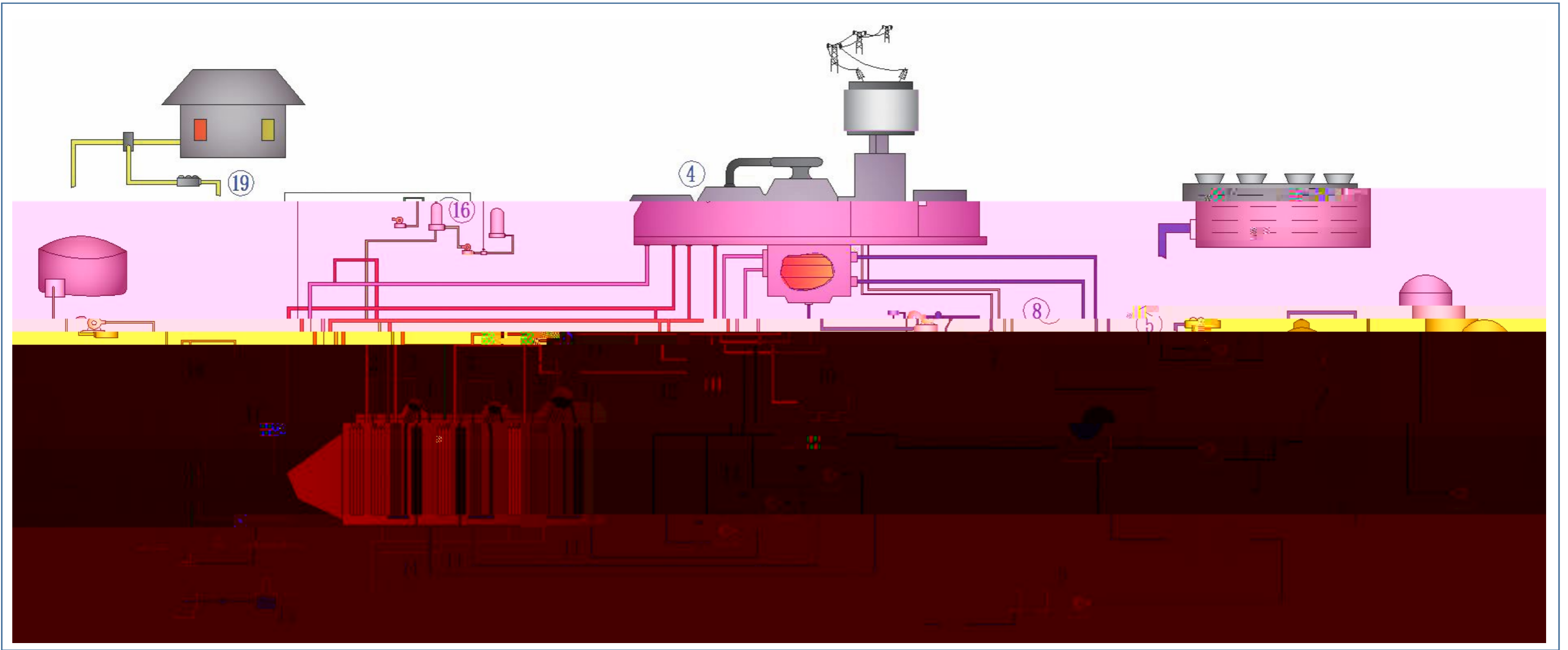

- | | | | | | | | | | | |
|----|-----|----|----|-----|-----|-----|-----|-------|-----|------|
| 1. | 3. | 5. | 7. | 9. | 11. | 13. | 15. | 17. | 19. | () |
| • | • | • | • | • | • | • | • | • | • | • |
| • | • | • | • | • | • | • | • | • | • | • |
| • | • | • | • | • | • | • | • | • | • | • |
| • | • | • | • | • | • | • | • | • | • | • |
| 2. | 4. | 6. | 8. | 10. | 12. | 14. | 1. | (SCR) | 18. | 1-19 |
| • | • | • | • | • | • | • | • | • | • | • |
| • | • / | • | • | • | • | • | • | • | • / | • |
| • | • | • | • | • | • | • | • | • | • | • |
| • | • / | • | • | • | • | • | • | • | • | • |
| • | • | • | • | • | • | • | • | • | • | • |

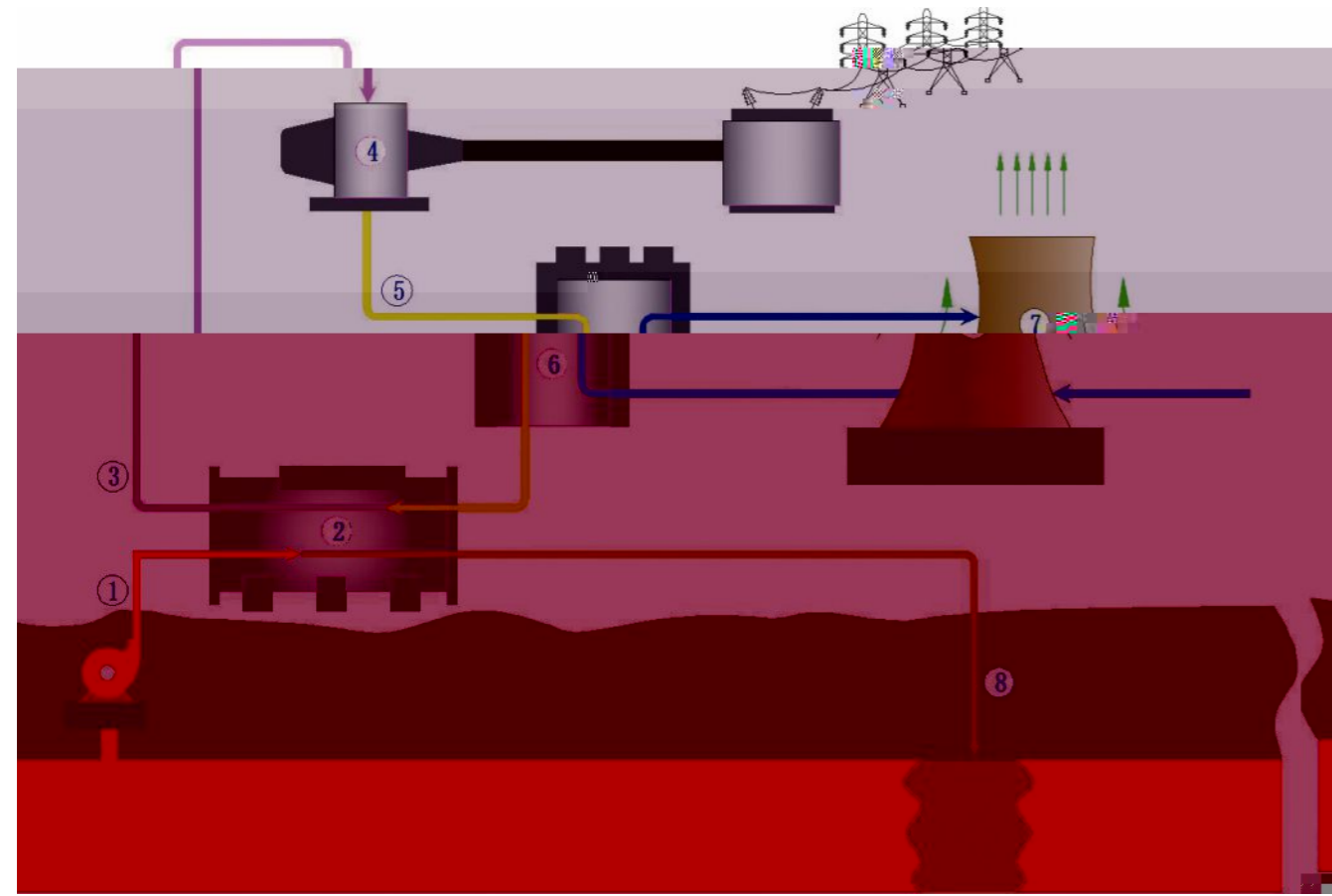

- | | | | |
|----|----|----|----|
| 1. | 3. | 5. | 7. |
| • | • | • | • |
| • | • | • | • |
| • | • | • | • |
| 2. | 4. | 6. | 8. |
| • | • | • | • |
| • | • | • | • |
| • | • | • | • |

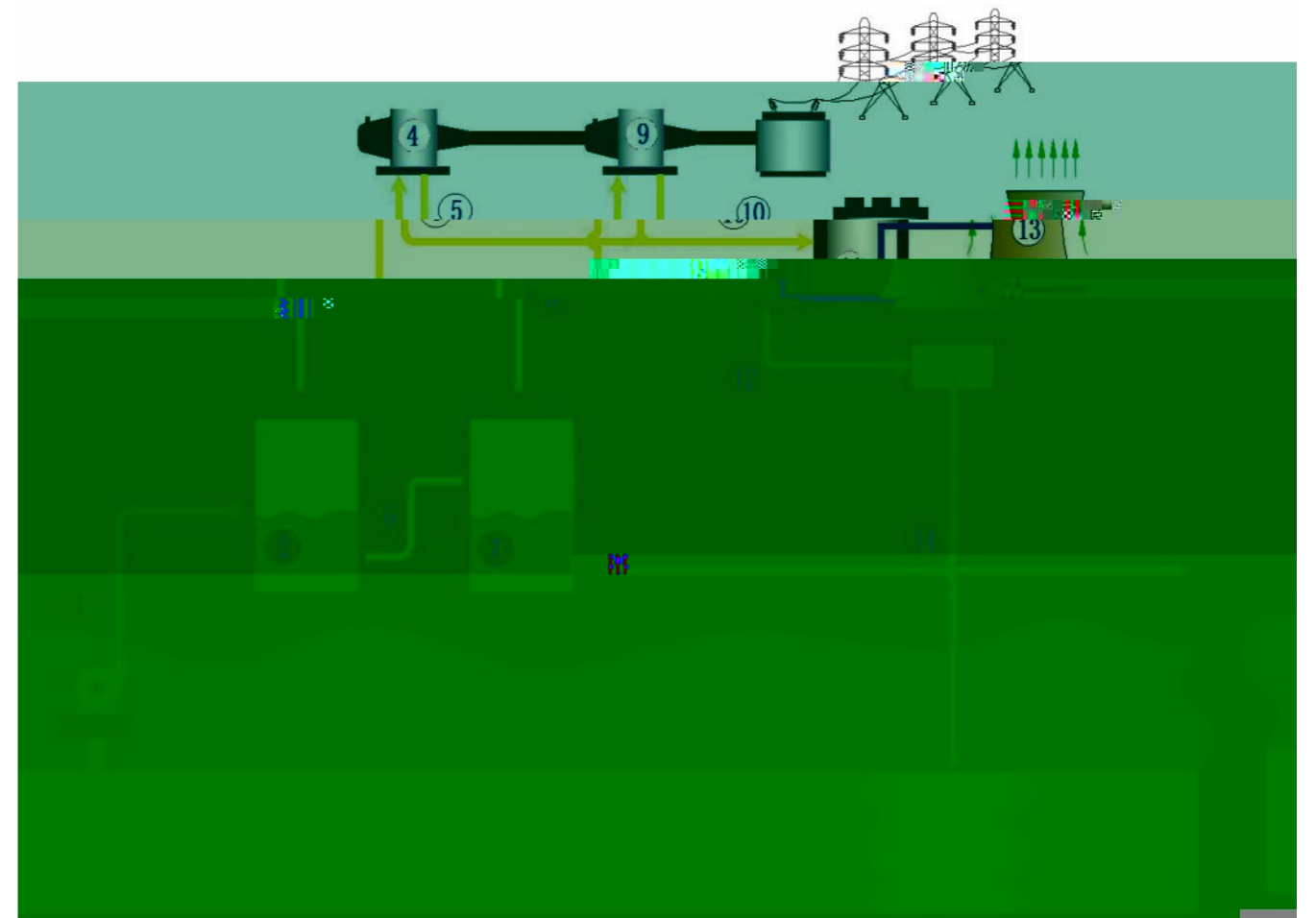

- | | | | | |
|----|------|----|-----|-----|
| 1. | 4.高压 | 7. | 10. | 13. |
| • | • | • | • | • |
| • | • | • | • | • |
| • | • | • | • | • |
| 2. | 5. | 8. | 11. | 14. |
| • | • | • | • | • |
| • | • | • | • | • |
| • | • | • | • | • |
| 3. | 6. | 9. | 12. | |
| • | • | • | • | |
| • | • | • | • | |
| • | • | • | • | |

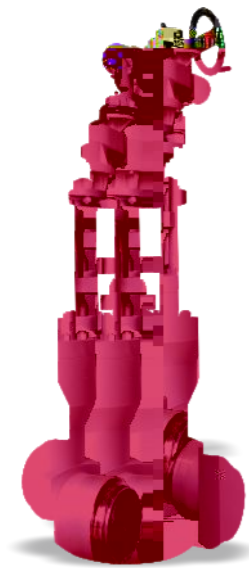

2"~30"(DN50~DN750)

CLASS900~CLASS 4500(PN150~PN760)

WCB/WC6/WC9/C12A/CF3M/CF8M/A105/F11/F22/F36/F91/
F92/F304/F304L/F304H/F316/F316L/F316H/F321/F347

-
-
-
-
-

2"~28"(DN50~DN700)

CLASS 300~CLASS 4500(PN50~PN760)

WCB/WC6/WC9/C12A/CF3M/CF8M/A105/F11/F22/F36/F91/
F92/F304/F304L/F304H/F316/F316L/F316H/F321/F347

- Class 300~600:
- Class 900~4500:
-
-
-
-
-



2"~24"(DN50~DN600)

CLASS 300~CLASS 4500(PN50~PN760)

WCB/WC6/WC9/C12A/CF3M/CF8M/A105/F11/F22/F36/F91/
F92/F304/F304L/F304H/F316/F316L/F316H/F321/F347

-
-
-
-
-
-
-

API6D

1/2"~2-1/2"(DN15~DN65)

CLASS 1500~CLASS 4500(PN250~PN760)

A105/F11/F22/F36/F91/F92/F304/F304L/F304H/F316/
F316L/F316H/F321/F347

-
-
-
-
-
-
-

CLASS>1700lb

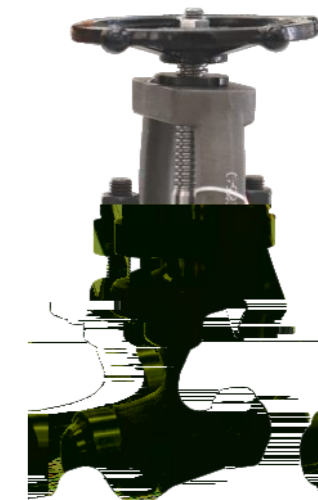



1/2"~24"(DN15~DN600)
 CLASS900~CLASS 4500(PN20~PN760)
 WCB/WC6/WC9/C12A/CF3M/CF8M/A105/F11/F22/F36/F91/
 F92/F304/F304L/F304H/F316/F316L/F316H/F321/F347

-
-
-
-
-
-

WCB / WC6 / WC9 / C12A / CF3M / CF8M

3"~60"(DN80~DN1500)
 CLASS 150~CLASS 600(PN20~PN110)
 WCB/WC6/WC9/C12A/CF3M/CF8M

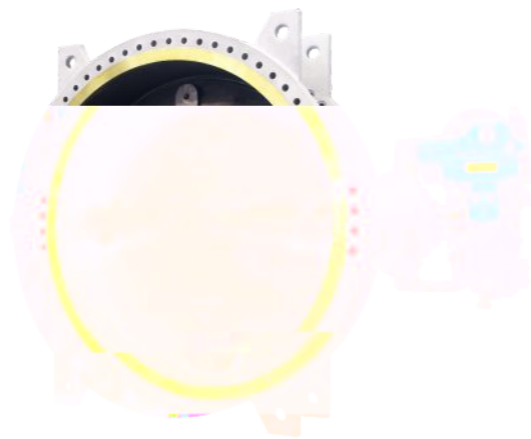

-
-
-
-
-
-

ISO 15848

API 607

3

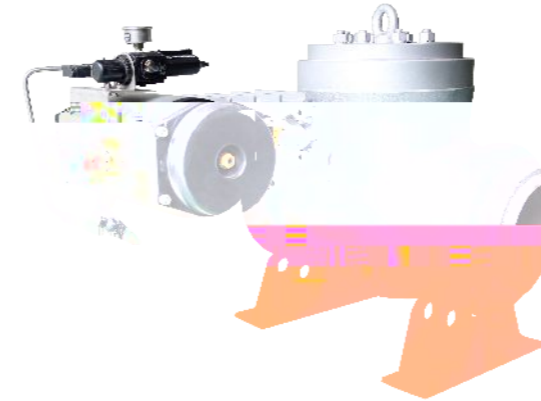

6"~42"(DN150~DN1050)
 CLASS 150~CLASS 2500(PN20~PN420)
 WCB/WC6/WC9/C12A/CF3M/CF8M/A105/F11/F22/F36/F91/
 F92/F304/F304L/F304H/F316/F316L/F316H/F321/F347

-
-
-
-
-
-

1s),

<80°C。

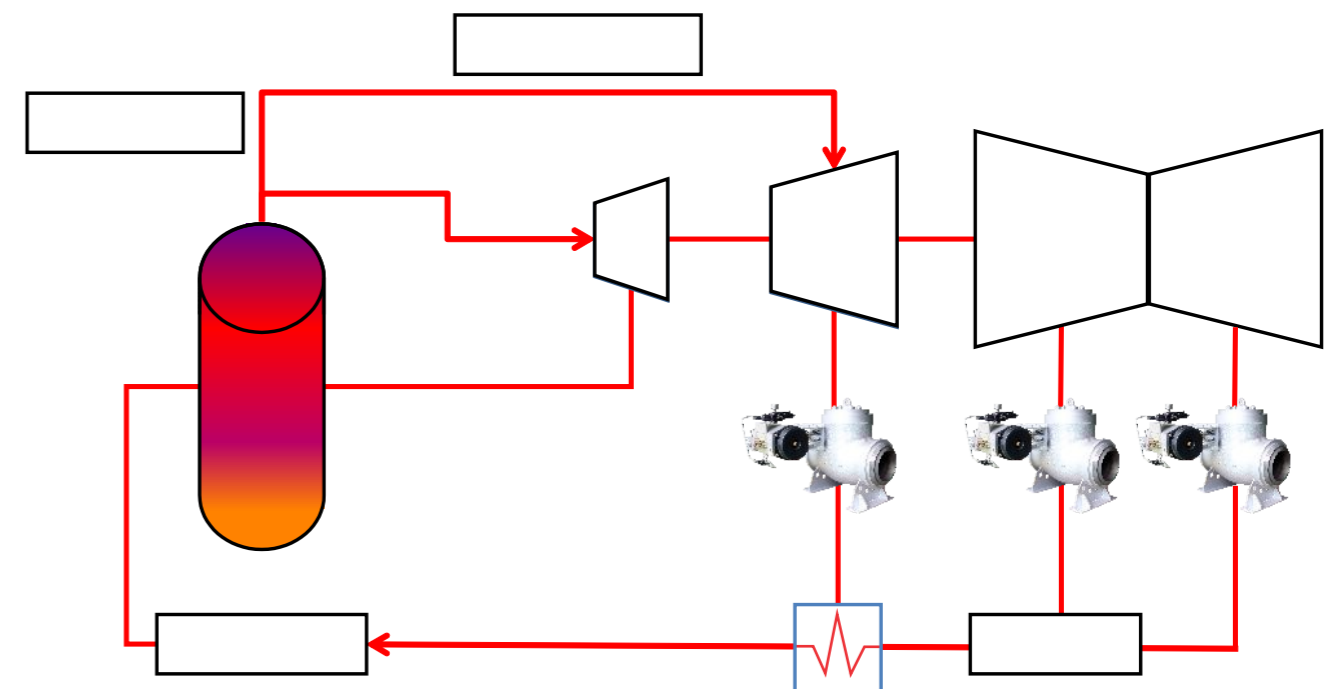



2"~24" (DN50~DN600)
 CLASS 900~CLASS 3500 (PN150~PN600)
 WCB/WC6/WC9/C12A/CF3M/CF8M/A105/F11/F22/F36/F91/
 F92/F304/F304L/F304H/F316/F316L/F316H/F321/F347

-
-
-
-
-

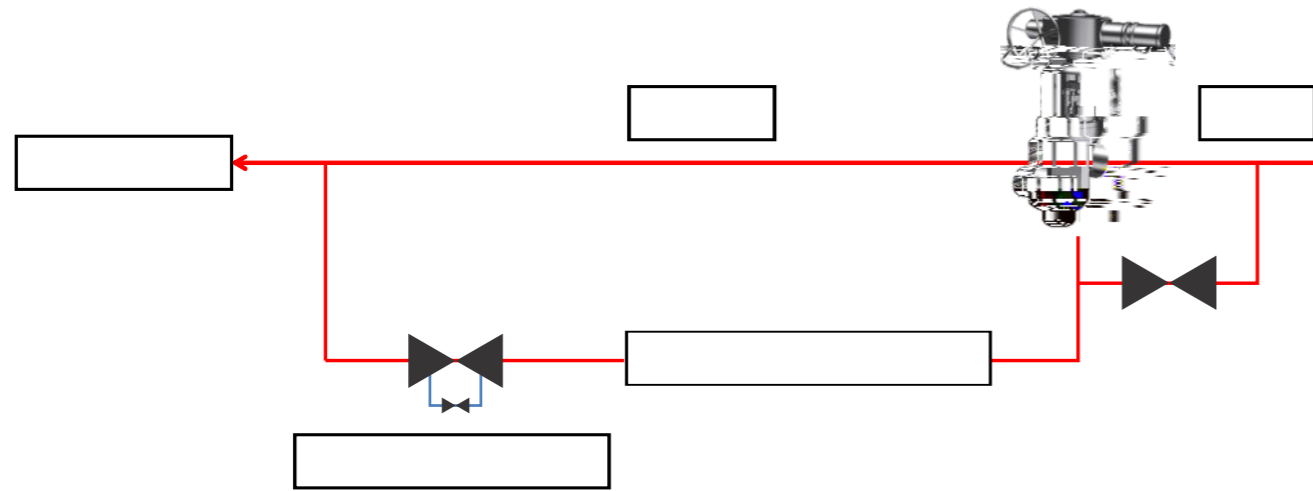

-
-

+ +

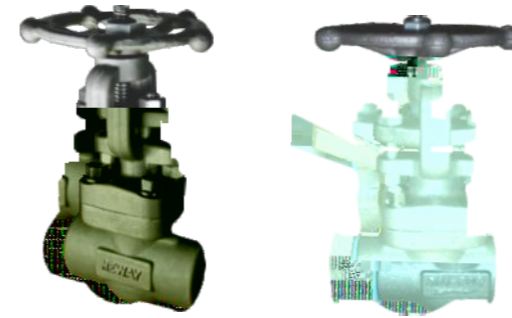

1/2"~2" (DN15~DN50)
 CLASS 150~CLASS 1500 (PN20~PN250)
 A105/F11/F22/F36/F91/F92/F304/F304L/F304H/F316/
 F316L/F316H/F321/F347

-
-
-
-
-
-
-
-

4"~8" (DN100~DN200)
 CLASS 150~CLASS 900 (PN20~PN150)
 WCB/WC6/WC9/C12A/CF3M/CF8M/A105/F11/F22/F36/F91/
 F92/F304/F304L/F304H/F316/F316L/F316H/F321/F347

-
-
-
-
-
-
-
-





3/4"~4"(DN20~DN100)
 CLASS 600~CLASS 2500(PN110~PN420)
 WCB/WC6/WC9/C12A/CF3M/CF8M/A105/F11/F22/F36/F91/
 F92/F304/F304L/F304H/F316/F316L/F316H/F321/F347

3/4"~16"(DN20~DN400)
 CLASS 150~CLASS 2500(PN20~PN420)
 WCB/WC6/WC9/C12A/CF3M/CF8M/A105/F11/F22/F36/F91/
 F92/F304/F304L/F304H/F316/F316L/F316H/F321/F347



s

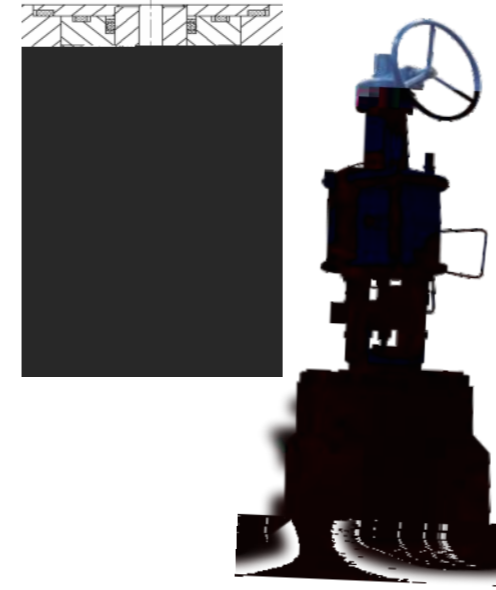

2"~8"(DN50~DN200)
 CLASS 900~CLASS 2500(PN150~PN420)
 WCB/WC6/WC9/C12A/CF3M/CF8M/A105/F11/F22/F36/F91/
 F92/F304/F304L/F304H/F316/F316L/F316H/F321/F347

1-1/2"~6"(DN45~DN150)
 CLASS 300~CLASS 2500(PN50~PN420)
 WCB/WC6/WC9/C12A/CF3M/CF8M/A105/F11/F22/F36/F91/
 F92/F304/F304L/F304H/F316/F316L/F316H/F321/F347

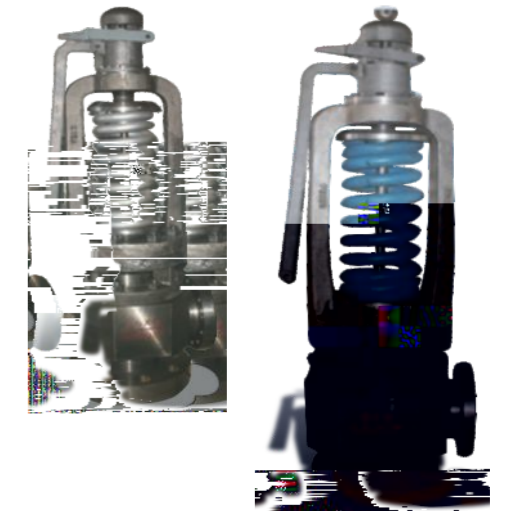

-
-
-

WCB/A105	-29	-425
F36	-29	-480
WC6/F11	-29	-540
WC9/F22	-29	-570
C12A/F91	-29	-600
F92	-29	-620
F304L/F316L	-29	-425
CF3M/CF8M/F304/F316/F321/F347	-29	-538
F304H/F316H	-29	-650

Cv

Cv

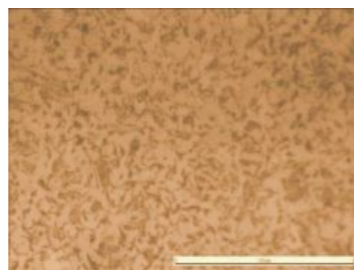
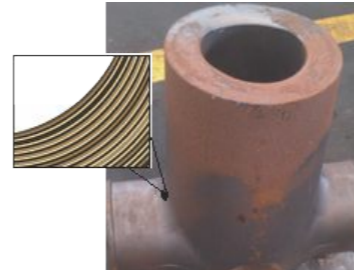
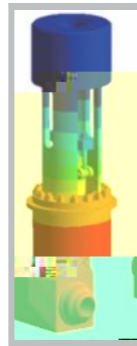
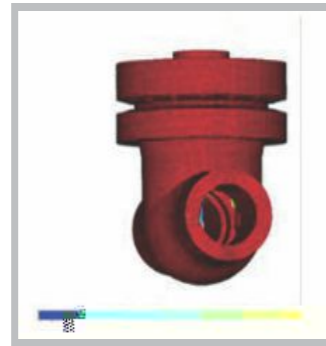
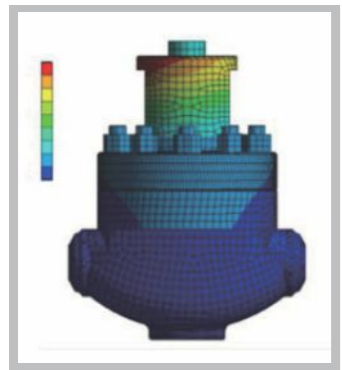
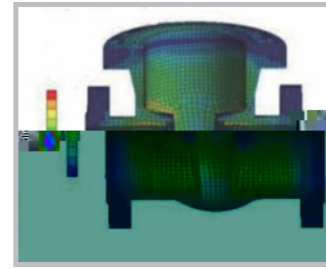
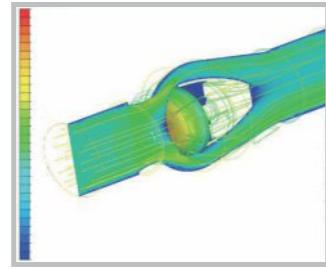
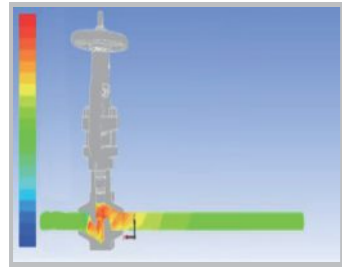

PMI、

RT)、

MT)、

UT)、

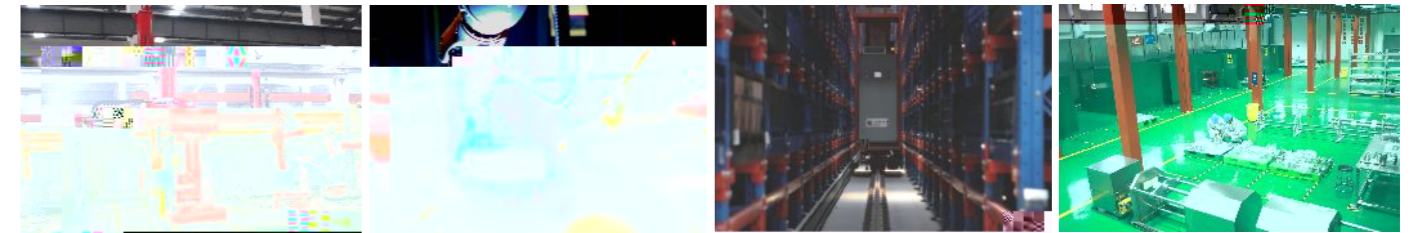

3D

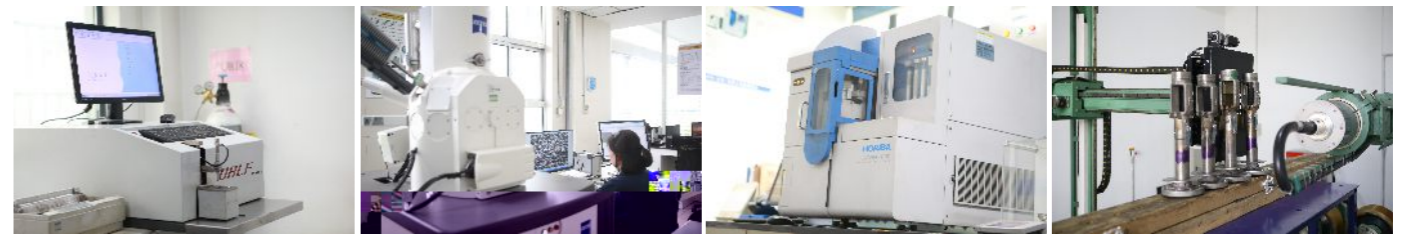

NHO分析

DR



-196

RT



成立于2014年

2,295



230,000
140,061

2006
2013



2008
2015

112,500
98,000



2008

40,000
20,000



2017

3,000
30,000



2020

30,000
19,000 ()
7,000 ()



18

12

()